

# T-1000 QUICK START GUIDE

This quick start guide explains basic instructions on how to unbox and set up the T-1000 UV 3D printer. For more information, please refer to T-1000 manual v1.8, available for download at [www.g3dsys.com](http://www.g3dsys.com).

## COMPONENTS

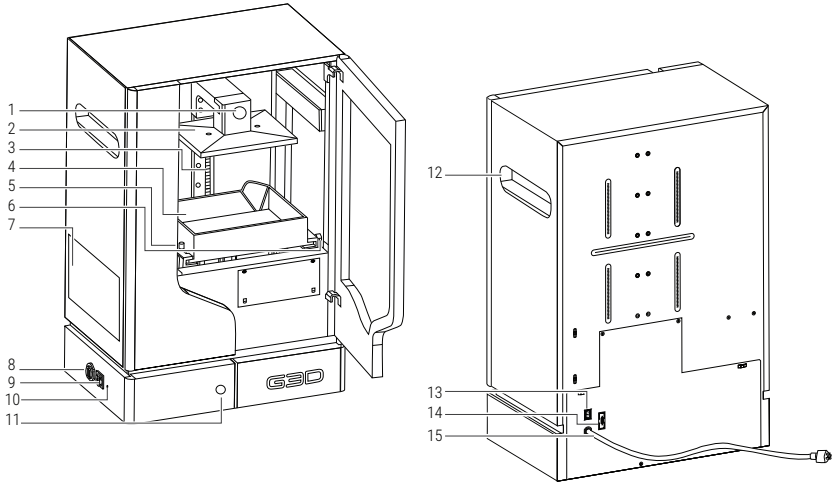

**1** Build Plate Lock Screw

**2** Build Plate

**3** Acme Thread

**4** Vat

**5** Vat Lock Screw

**6** Calibration Lever

**7** Servo Panel

**8** USB Port

**9** Ethernet Port

**10** WiFi Reset

**11** Power Button

**12** Lifting Handle

**13** Main Switch

**14** Fuse Holder

**15** Power Cable

## ACCESSORIES CHECKLIST

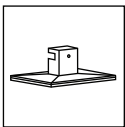

Build Plate

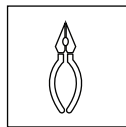

Clippers

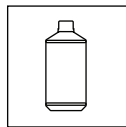

\*Resin

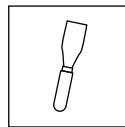

Scraper

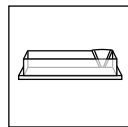

Vat

\* Shake the resin bottle before each use.

# UNBOXING AND SETTING UP THE T-1000

## 1 TRIM THE TAPED EDGES

Use a cutter to trim the taped edges.

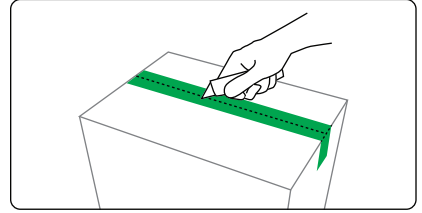

## 2 CHECK THE ACCESSORIES

Lift the accessory box lifting handles. Open the accessory box to check if the accessories are inside.

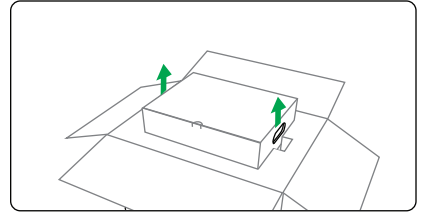

## 3 REMOVE THE ACCESSORY BOX

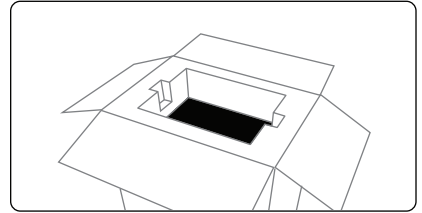

## 4 TILT THE T-1000 BOX

Slightly tilt the T-1000 box. Make sure to hold or lean the T-1000 box against a wall to prevent from falling.

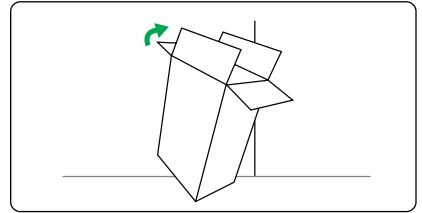

## 5 TRIM THE BOTTOM TAPED EDGES

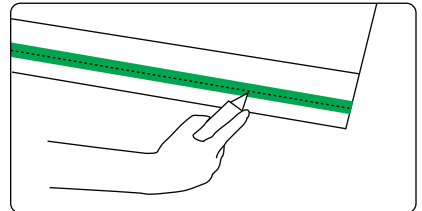

## 6 OPEN THE BOTTOM FLAPS

Unfold the bottom flaps of the T-1000 box.

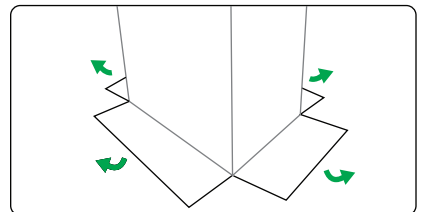

# UNBOXING AND SETTING UP THE T-1000

## 7 REMOVE THE ACCESSORY FOAM SUPPORT

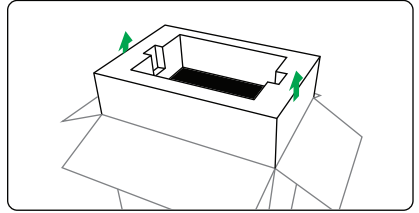

## 8 LIFT THE T-1000 BOX

Remove the plastic cover of the T-1000.

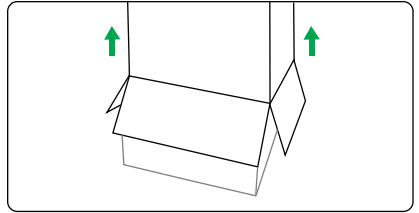

## 9 LIFT THE T-1000 UV 3D PRINTER

Printer can be heavy for one person. 2 person lift is recommended. Move up the lifting handles of the printer to separate the printer from the bottom foam support. Place the printer on a flat ground.

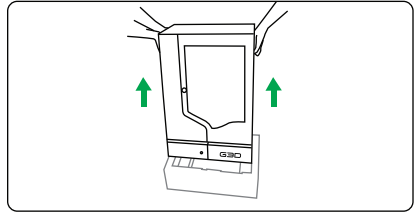

## 10 REMOVE BUILD PLATE LOCK SCREW

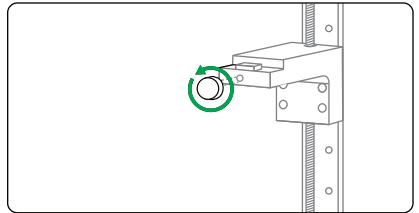

## 11 INSERT THE BUILD PLATE

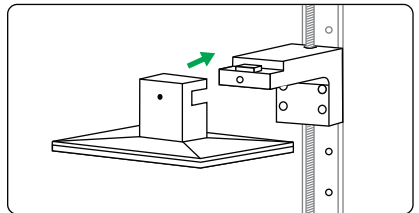

## 12 LOCK BUILD PLATE LOCK SCREW

Insert and lock the build plate lock screw.

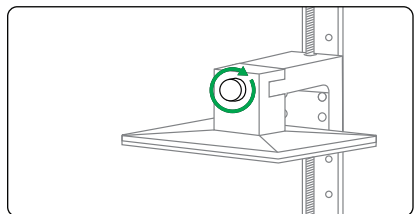

# UNBOXING AND SETTING UP THE T-1000

## 13 UNTIGHTEN THE VAT LOCK SCREWS

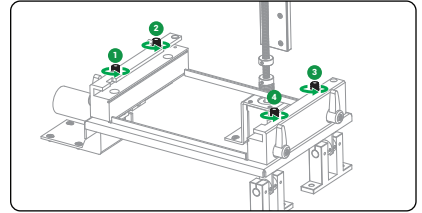

## 14 INSERT THE VAT

Max and min line on the vat should be facing front and the spout should be located at the back right position of T-1000. See T-1000 Vat Guide for details, attached on the vat. Do not remove the FEP film on the vat. It is for the vat's protection, manufacturer's warranty will be void if it's removed.

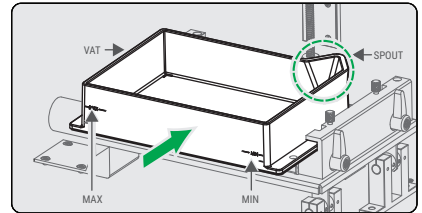

## 15 TIGHTEN THE VAT LOCK SCREWS

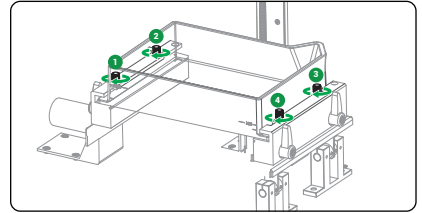

## 16 PLUG THE POWER CABLE

Uninterruptible power supply recommended.

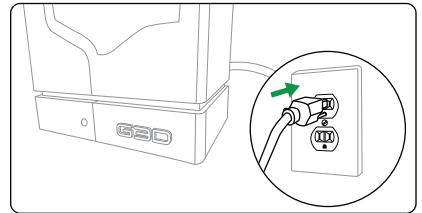

## 17 TURN ON THE MAIN SWITCH

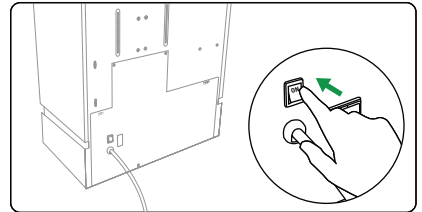

## 18 PRESS THE POWER BUTTON

Push power button for 2 - 3 seconds until a red led illuminates from the power button.

